

PR 7b Pos 2. Askefang. 1Stk. 1:25  
Rev. Flusjern.

PR 7b Pos 3. Beskyttelsesplade 1Stk. 1:5  
Rev. Flusjern.

PR 7b Pos 4. 3/4 Damprese. 9Stk. 1:1  
Rev. Flusjern.

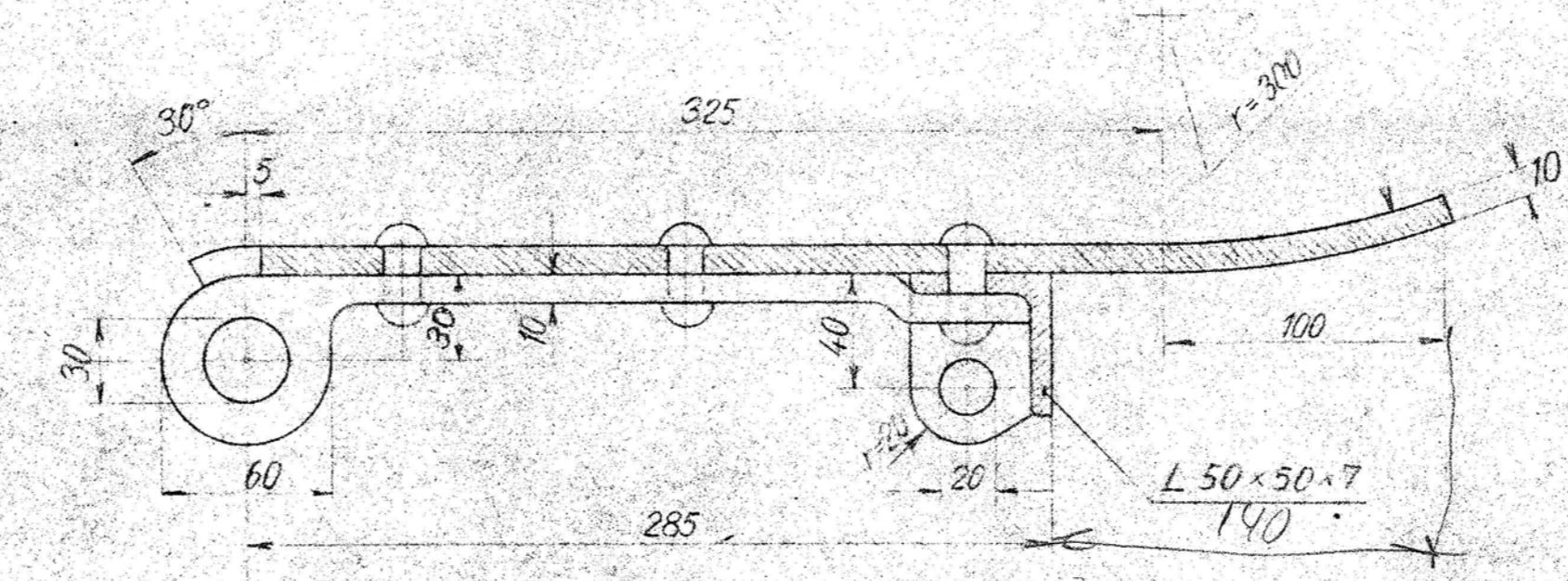
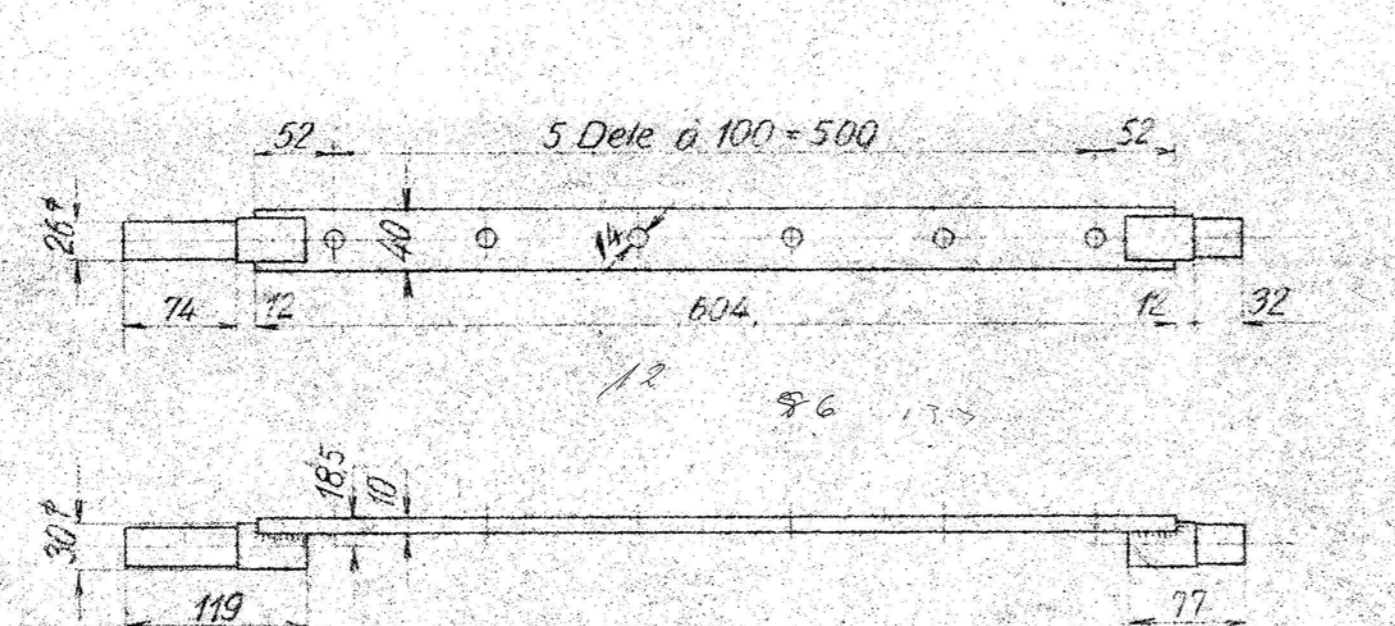
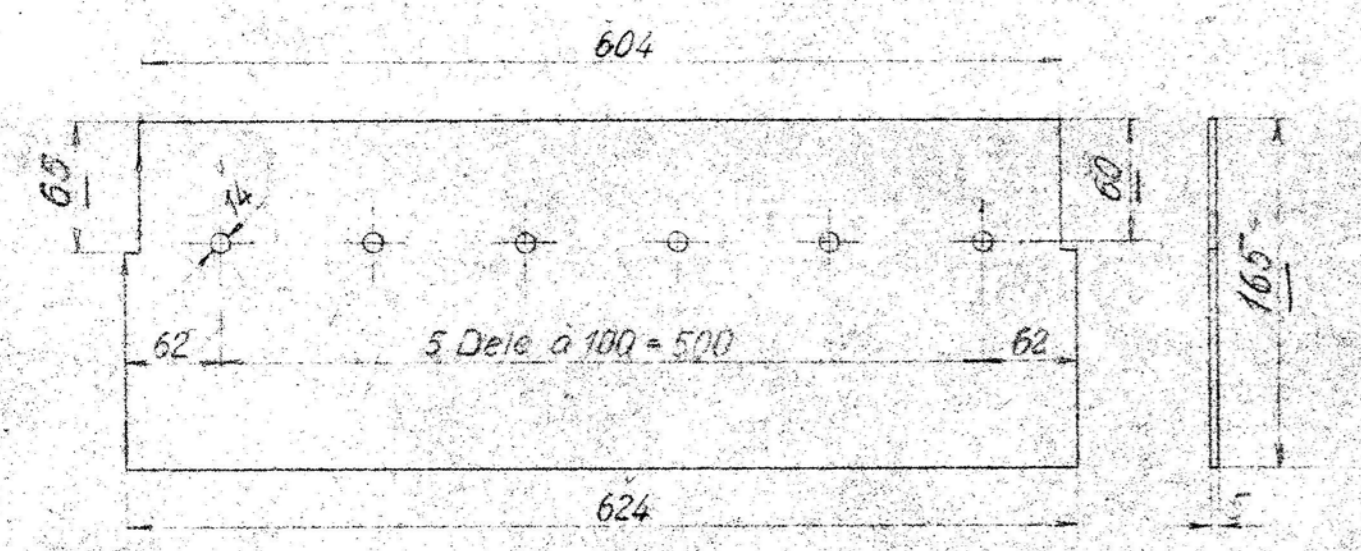

PR 7b Pos 5. Øverste Mel-klop. 1Stk. 1:5  
Rev. Flusjern.

PR 7b Pos 9. Beslag. 2Stk. 1:5  
Rev. Flusjern.

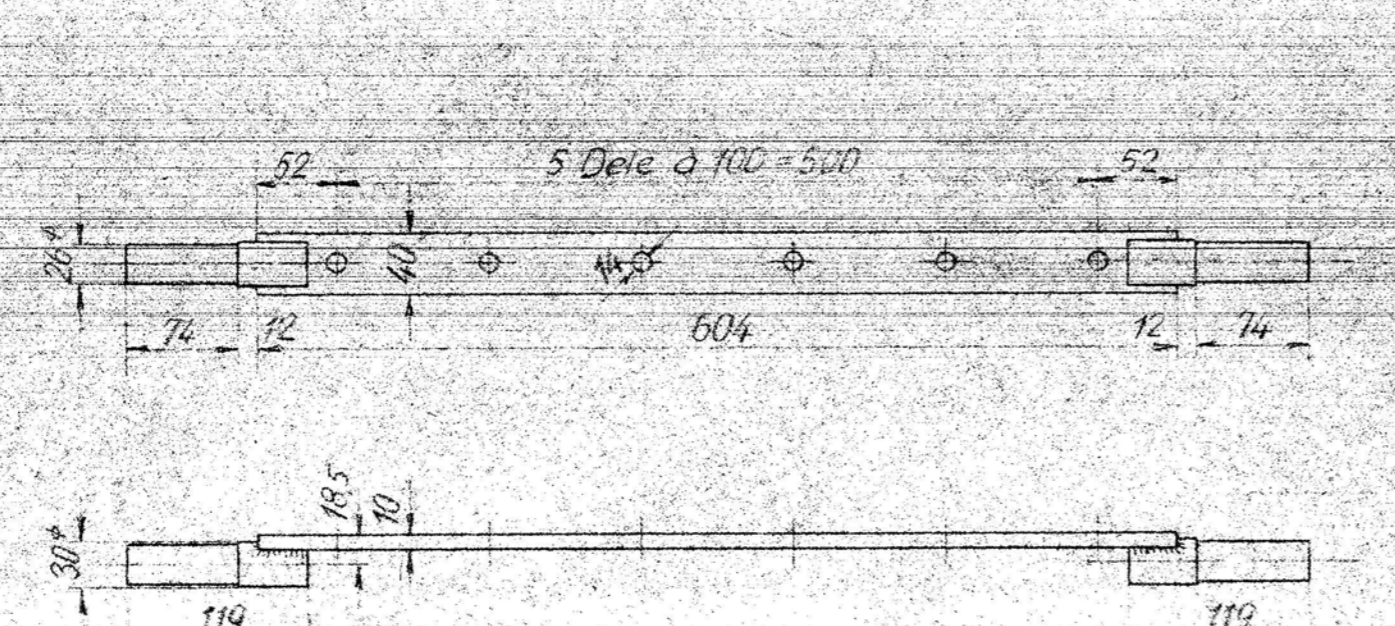
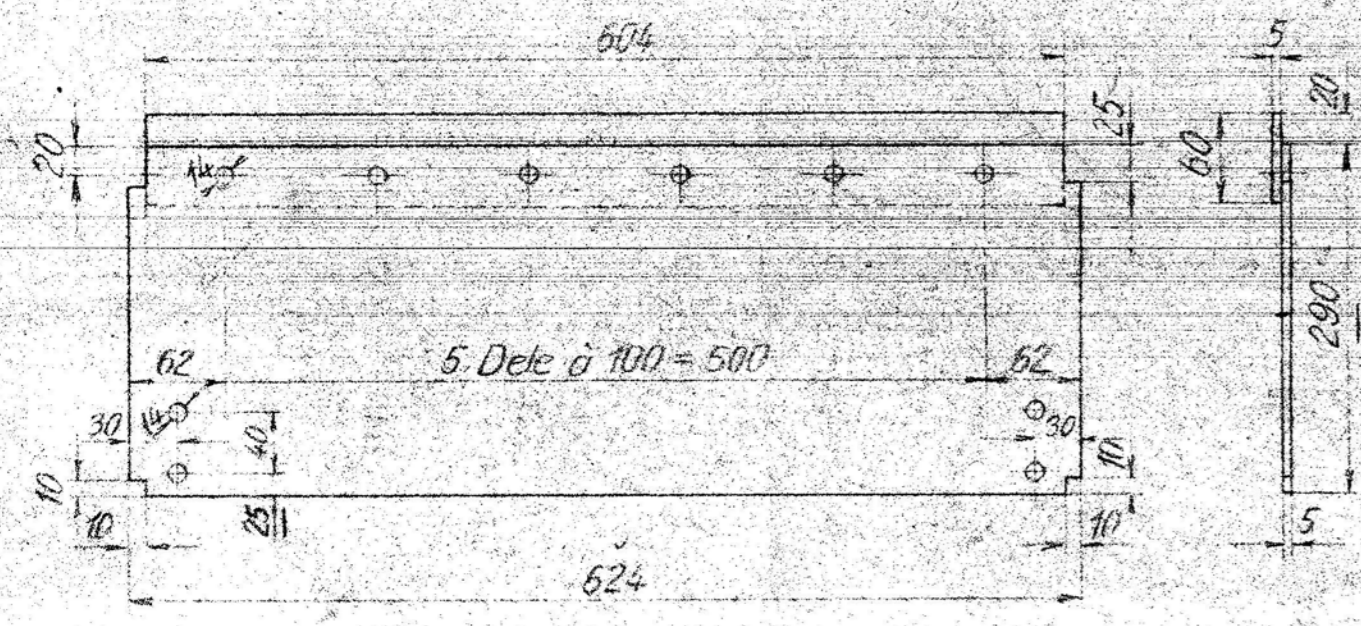

PR 7b Pos 6. Nederste Mel-klop. 1Stk. 1:5  
Rev. Flusjern.

PR 7b Pos 10. Beslag. 2Stk. 1:5  
Rev. Flusjern.

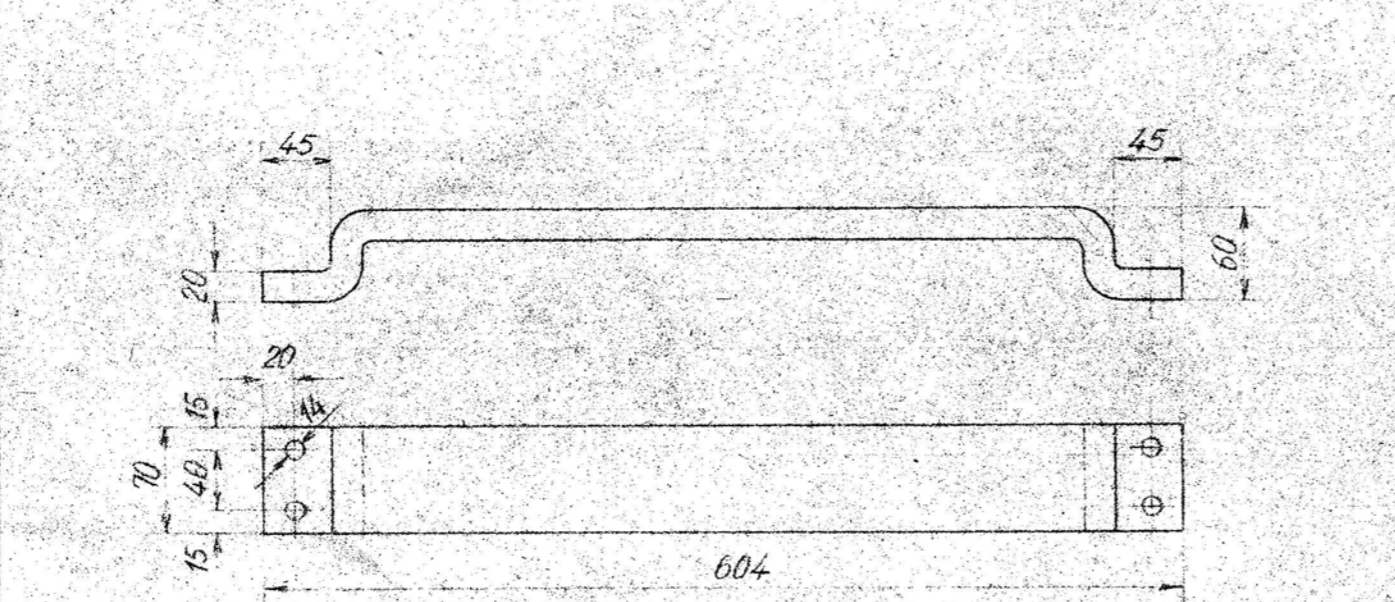
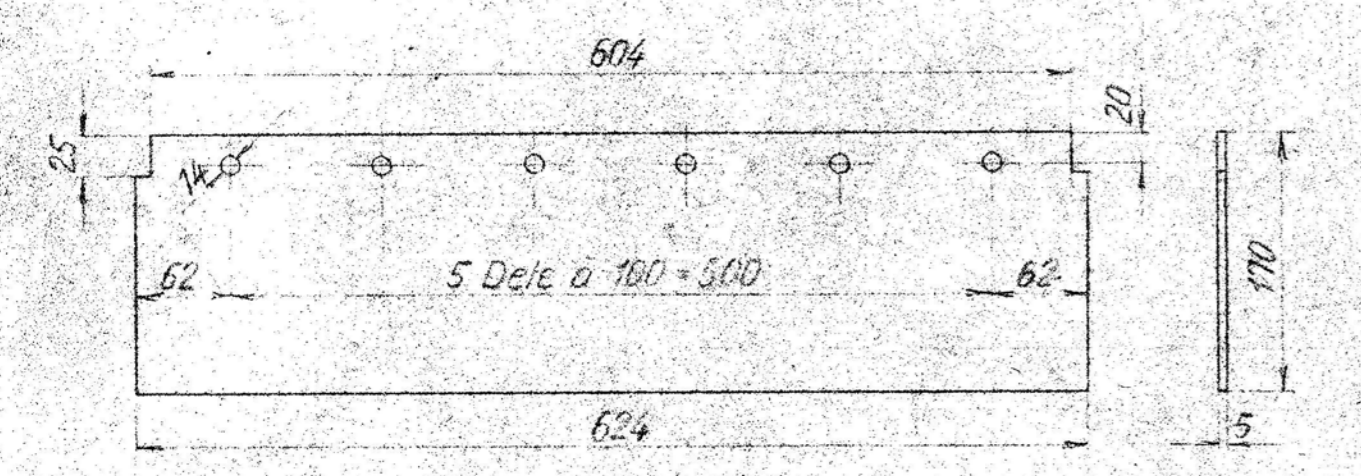

PR 7b Pos 7. Øverste Forklop. 1Stk. 1:5  
Rev. Flusjern.

PR 7b Pos 11. Kontravægt. 2Stk. 1:5  
Rev. Flusjern.

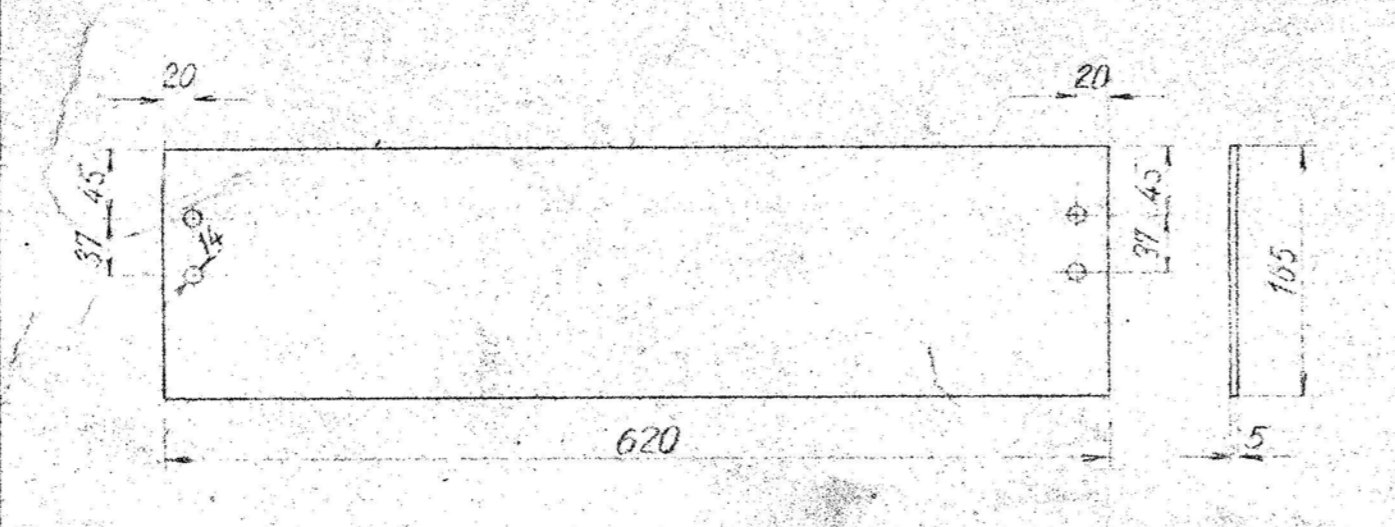
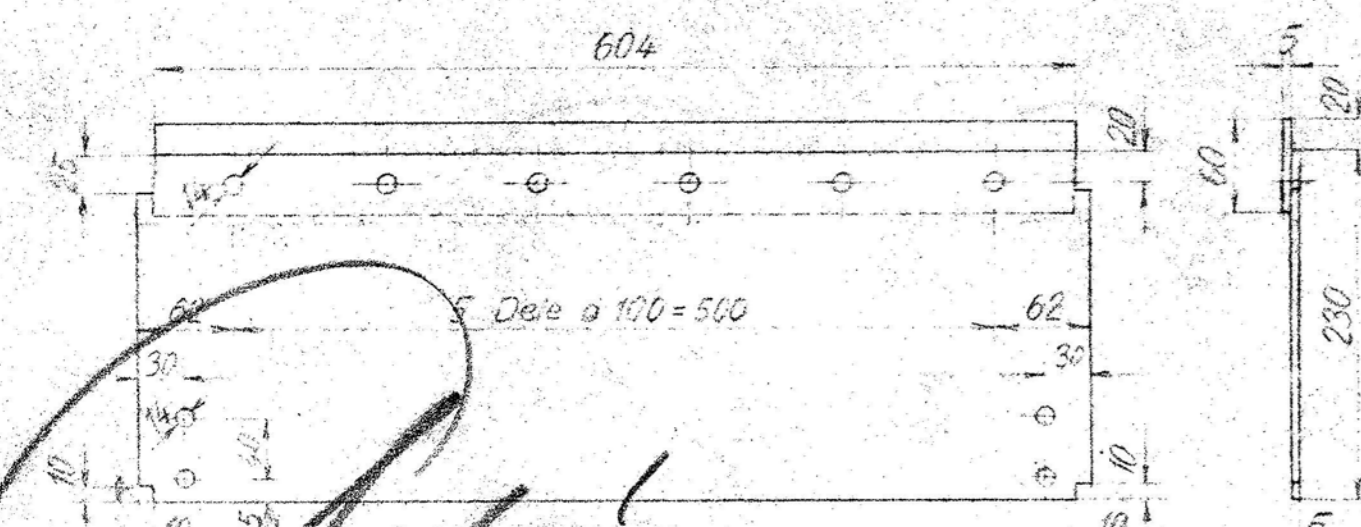

PR 7b Pos 8. Nederste Forklop. 1Stk. 1:5  
Rev. Flusjern.

PR 7b Pos 12. Bagklap. 1Stk. 1:5  
Rev. Flusjern.

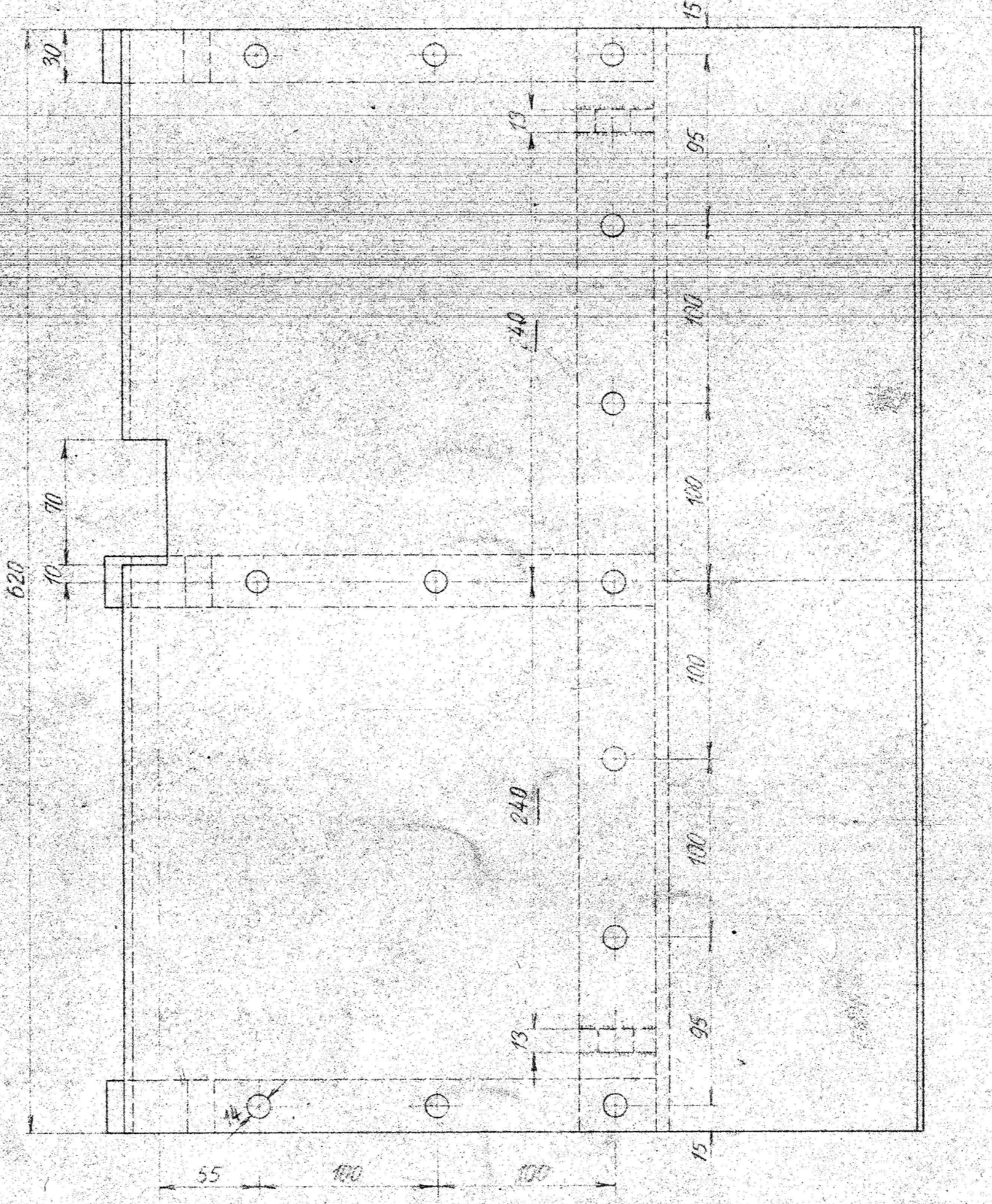

43  
21  
23  
2  
30

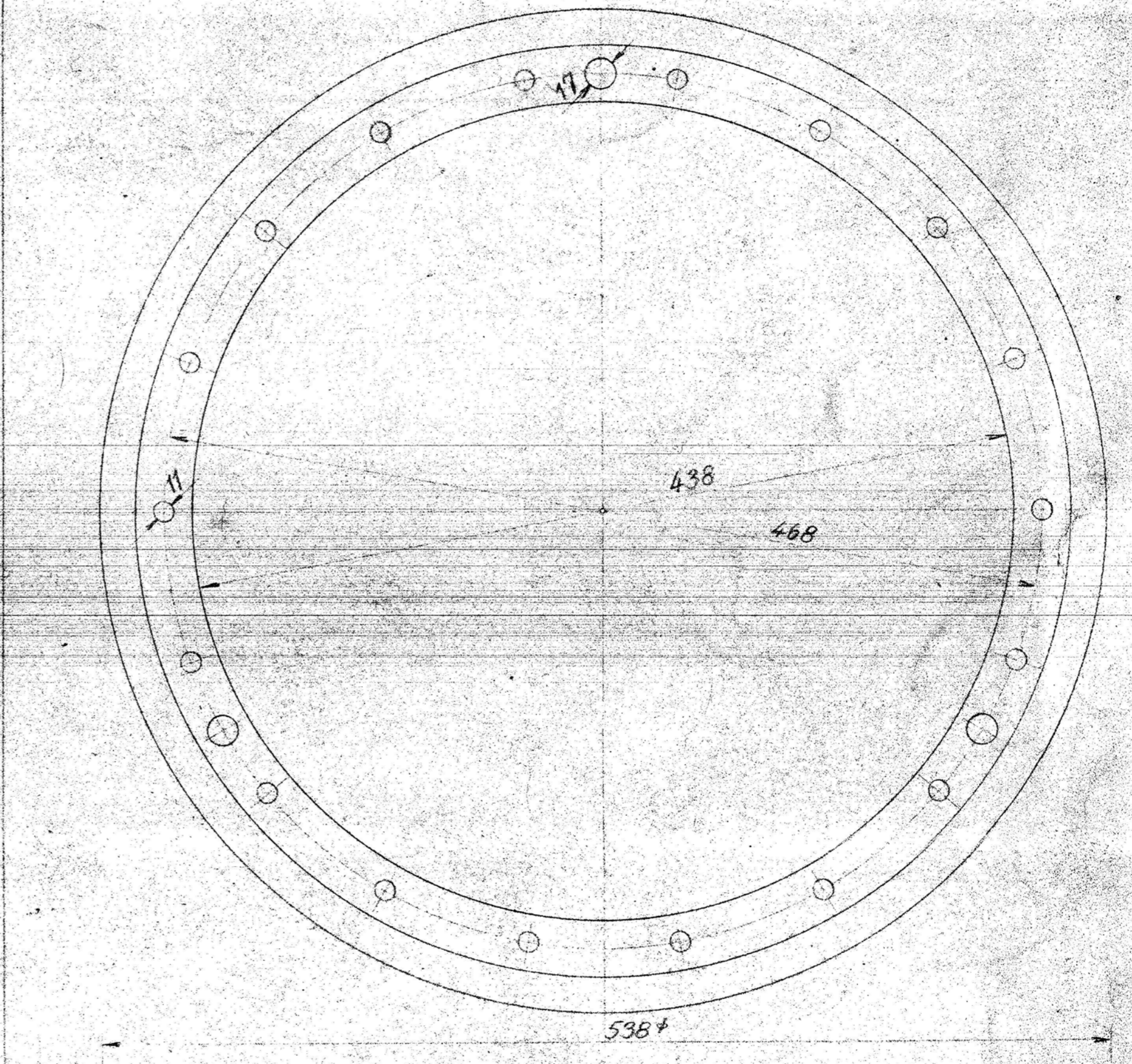

PR 7b Pos 14. Bundakse. 1Stk. 1:2  
Rev. Flusjern.

1	Bundakse	14	Flusj
1	Bundklap	13	do
1	Bagklap	12	do
2	Kontravægt	11	do
2	Beslag	10	do
2	Beslag	9	do
1	Nederste Forklop	8	do
1	Øverste do	7	do
1	Nederste Melenklop	6	do
1	Øverste do	5	do
9	3/4 Damprese	4	do
1	Beskyttelsesplade	3	do
1	Askefang	2	do

Styktal	Genstand	Nr	Material
Forordning	Pos 5046 ændret B. 3-5-44	ES	

Maskinafdelingens Tegnestue ved Landbaneteket, København.

*Signature*  
11 AUG. 1944

De danske Statsbaner  
Maskinafdelingen  
Detaller til Askekasse  
paa  
Loko Ltr. PR  
Nudes-  
1:1:5  
1:25  
A.B.  
Tegn. 19-8-43  
Rev.  
Com.  
PR 7b

PR 7b